



CLAMP FITTINGS....

Clamp Style Fittings are most popular for easy assembly and breakdown of process lines and equipment. We offer Clamp Fittings in T304 and T316L materials in 1/2" through 12" sizes.

Gaskets for Clamp Fittings are available in several different materials, Buna-N, EPDM, Silicone, Tef-Steel®, Teflon®, and Viton®. Lightweight and heavy-duty clamps complete the unions. Clamp Fittings meet all 3A requirements.

CLAMP FITTING SPECIFICATIONS....

Size Range: 1/2" OD through 12" OD

Materials: T304
T316L

Finish: No. 7 - ID & OD
No. 5 - OD only
No. 3 - ID only
No. 1 - unpolished

ORDERING SPECIFICATIONS....

Specify:

- Quantity
- Product description or Part No.
- Size
- Material Type
- Polish Requirements

CLAMP TYPE

VNE	ALFA LAVAL	WAUKESHA / SPX	BRADFORD	STEEL & O'BRIEN
EG2C	2CMP	2CMP	B2CMP	2CMP
EG2C31CC	2CMP-31MP	2CMP-31MP	B2CM31MP	2CMP-31MP
EG2FPR	2FMP-14	2FMP-14	B2FMP-14	2FMP-14
EG2WU	----	2UMP	B2WVMP	2UMP
EG2FTR	2FMP-15	2FMP-15	B2FMP-15	2FMP-15
EG2K	2KMP	2KMP	B2KMP	2KMP
EG7	7MP	7MP	B7MP	7MP
EG7R	7RMP	7RMP	B7MP	7RMP
EG9	9MP	9MP	B9MP	9MP
EG13	13MHLA	----	13MHLA	----
13MHHM	13MHHM	13MHHM	13MHHM-SN	13MHHM
13MHP	13MHP	13MHP	13MHP	13MHP
EG14HT	14MPHT	14MPHT	14MPHT	14MPHT
EG14W	14MPW	14MPW	14MPW	14MPW
EG14WL	14WLMP	14WLMP	14WLMP	14WLMP
EG14AM7	L14AM7	L14AM7	14AM7	L14AM7
EG2CS	14WMP	14WMP	14WMP	14WMP
EG14RT	14MPHR	14MPHR	14MPHR	14MPHR
EG16A	16AMP	16AMP	16AMP	16AMP
EG17PR	17MP-14	17MP-14	17MP-14	17MP-14
EG17TR	17MP-15	17MP-15	17MP-15	17MP-15
EG21	21MP	21MP	21MP	21MP
EG22	22MP	22MP	22MP	22MP
EG31R	31RMP	31RMP	----	31RMP
EG31CC	31-14MP	31-14MP	B3114MP	31-14MP
EG32CC	32-14MP	32-14MP	B3214MP	32-14MP
EG31PC	31PMP	31PMP	B14C31	31PMP
EG32PC	32PMP	32PMP	B14C32	32PMP
EG31CP	31MPP	31MPP	B31-14	31MPP
EG32CP	32MPP	32MPP	B32-15	32MPP
EG31TC	31TMP	31TMP	B15-C31	31TMP
EG32TC	32TMP	32TMP	B15-C32	32TMP
EG31CT	31MPT	31MPT	BC31-15	31MPT
EG32CT	32MPT	32MPT	BC32-15	32MPT
EG40	40MPU	40MPU	40MP-U	40MPU
EG40T	40MPG	40MPG	40MP-G	40MPG
EG23B	23BMP	23BMP	B28BMP	23BMP
EG28A	28AMP	28AMP	B28AMP	28AMP
EG28B	28BMP	28BMP	B31WMP	28BMP

CLAMP FITTINGS

EG2C - 90° ELBOW

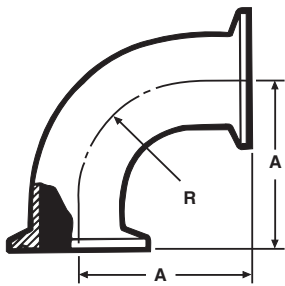

Size Tube OD	A	R
1	2.000	1.500
1 1/2	2.750	2.250
2	3.500	3.000
2 1/2	4.250	3.750
3	5.000	4.500
4	6.625	6.000
6	9.875	9.000
8	12.937	12.000

EG2WU - CLAMP 180° U-BEND

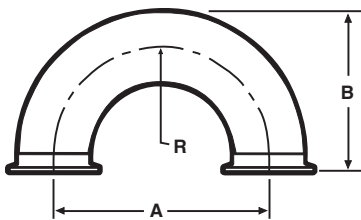

Size Tube OD	A	B	R
1/2	1.500	1.500	0.750
3/4	2.250	2.000	1.125
1	3.000	2.500	1.500
1 1/4	3.750	3.000	1.875
1 1/2	4.500	3.500	2.250
2	6.000	4.500	3.000
2 1/2	7.500	5.500	3.750
3	9.000	6.500	4.500
4	12.000	8.625	6.000
6	18.000	12.875	9.000

EG2FPR - 90° ELBOW

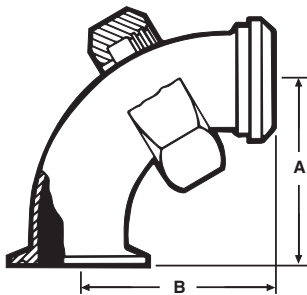

Size Tube OD	A	B
1	2.000	2.875
1 1/2	2.750	2.968
2	3.500	3.718
2 1/2	4.250	4.593
3	5.000	5.406
4	6.625	7.218

EG2FTR - 90° ELBOW

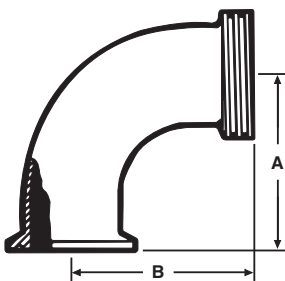

Size Tube OD	A	B
1	2.000	2.187
1 1/2	2.750	2.968
2	3.500	3.718
2 1/2	4.250	4.593
3	5.000	5.406
4	6.625	7.218

CLAMP FITTINGS

EG2C31CC - 90° REDUCING ELBOW (Non-Tapered)

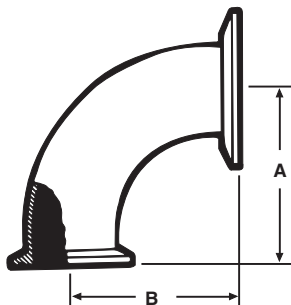

Size Tube OD	A	B
2 x 1	2.000	2.000
2 x 1 1/2	2.750	2.750
2 1/2 x 1 1/2	2.750	2.750
2 1/2 x 2	3.500	3.500
3 x 1 1/2	2.750	2.750
3 x 2	3.500	3.500
3 x 2 1/2	4.250	4.250
4 x 2 1/2	4.250	4.375
4 x 3	5.000	5.125
6 x 4	6.625	6.875

EG231-FPR 90° REDUCING ELBOW (Non-Tapered)

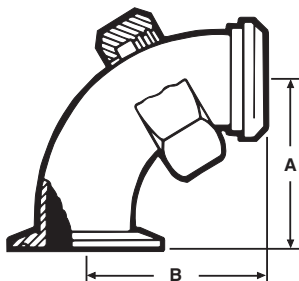

Size Tube OD	A	B
2 x 1	2.000	2.187
2 x 1 1/2	2.750	2.968
2 1/2 x 1 1/2	2.750	2.968
2 1/2 x 2	3.500	3.718
3 x 1 1/2	2.750	2.968
3 x 2	3.500	3.718
3 x 2 1/2	4.250	4.593
4 x 2 1/2	4.375	4.593
4 x 3	5.125	5.406

EG2C31PR - 90° REDUCING ELBOW (Non-Tapered)

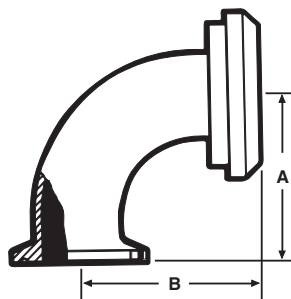

Size Tube OD	A	B
2 x 1	2.000	2.250
2 x 1 1/2	2.750	3.000
2 1/2 x 1 1/2	2.750	3.031
2 1/2 x 2	3.500	3.781
3 x 1 1/2	2.750	3.593
3 x 2	3.500	3.843
3 x 2 1/2	4.250	4.593
4 x 2 1/2	4.250	4.687
4 x 3	5.000	5.437

CLAMP FITTINGS

EG2K - 45° ELBOW

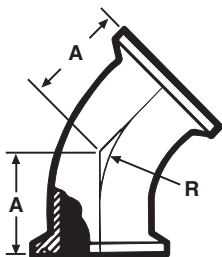

Size Tube OD	A	R
1	1.125	1.500
1 1/2	1.437	2.250
2	1.750	3.000
2 1/2	2.062	3.750
3	2.375	4.500
4	3.125	6.000
6	4.625	9.000
8	5.312	12.000

EG7 - TEE

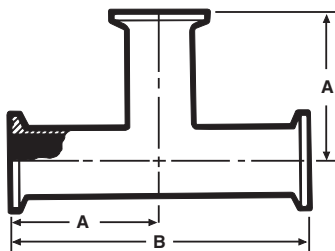

Size Tube OD	A	B
1	2.375	4.750
1 1/2	2.750	5.500
2	3.500	7.000
2 1/2	3.500	7.000
3	3.750	7.500
4	4.500	9.000
6	6.500	13.000
8	9.937	19.875

EG7R - REDUCING TEE

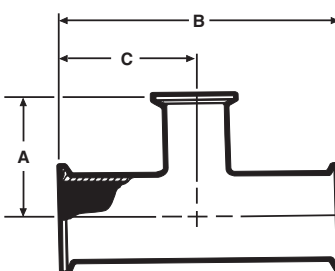

Size Tube OD	A	B	C
1 1/2 x 1	1.875	4.312	2.156
2 x 1	2.125	5.125	2.562
2 x 1 1/2	2.406	5.125	2.562
2 1/2 x 1 1/2	2.656	5.687	2.843
2 1/2 x 2	2.812	5.687	2.843
3 x 1 1/2	2.906	6.187	3.093
3 x 2	3.062	6.187	3.093
3 x 2 1/2	3.093	6.187	3.093
4 x 2	3.593	8.125	4.062
4 x 2 1/2	3.593	8.125	4.062
4 x 3	3.593	8.125	4.062
6 x 3	6.125	13.000	6.500
6 x 4	6.250	13.000	6.500

CLAMP FITTINGS

EG9 - CROSS

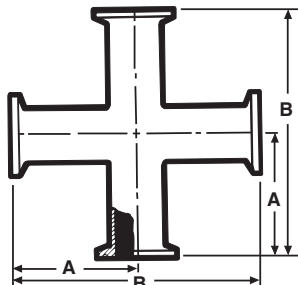

Size Tube OD	A	B
1	2.375	4.750
1 1/2	2.750	5.500
2	3.500	7.000
2 1/2	3.500	7.000
3	3.750	7.500
4	4.500	9.000
6	8.875	17.340

EG14AM7 - WELDING FERRULE

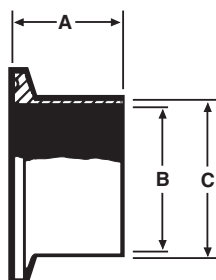

Size Tube OD	A	B	C
1/2	2.000	0.370	0.500
3/4	2.000	0.620	0.750
1	1.125	0.870	1.000
1 1/2	1.125	1.370	1.500
1 1/4	1.125	1.120	1.250
2	1.125	1.870	2.000
2 1/2	1.125	2.370	2.500
3	1.125	2.870	3.000
4	1.125	3.834	4.000
5	1.500	4.782	5.000
6	1.500	5.780	6.000
8	1.500	7.782	8.000
10	1.500	9.732	10.000
12	1.500	11.732	12.000

EG14R - RECESSLESS FERRULE (Expanding)

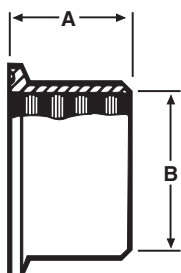

Size Tube OD	A	B
1	0.750	1.000
1 1/2	1.125	1.500
2	1.312	2.000
2 1/2	1.375	2.500
3	1.437	3.000
4	1.500	4.000

CLAMP FITTINGS

EG2CS - SHORT WELDING FERRULE

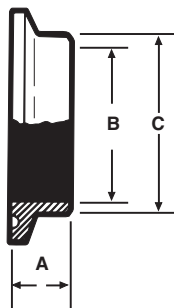

Size Tube OD	A	B
1/4	0.500	0.120
3/8	0.500	0.245
1/2	0.500	0.370
5/8	0.500	0.495
3/4	0.500	0.620
1	0.500	0.870
1 1/4	0.500	1.120
1 1/2	0.500	1.370
2	0.500	1.870
2 1/2	0.500	2.370
3	0.500	2.870
4	0.625	3.834
5	0.750	4.780
6	0.875	5.780
8	0.937	7.782
10	0.937	9.732
12	0.937	11.732

EG2CS31D - SHORT REDUCING CLAMP FERRULES

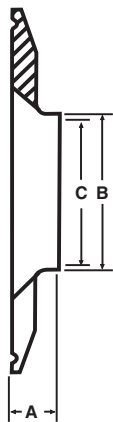

Size Tube OD	A	B	C
1 x 1/2	0.500	0.500	0.370
1 x 3/4	0.500	0.750	0.620
1 1/2 x 1	0.500	1.000	0.870
2 x 1	0.500	1.000	0.870
2 x 1 1/2	0.500	1.500	1.370
2 1/2 x 1 1/2	0.500	1.500	1.370
2 1/2 x 2	0.500	2.000	1.870
3 x 1	0.500	1.000	0.870
3 x 1 1/2	0.500	1.500	1.370
3 x 2	0.500	2.000	1.870
3 x 2 1/2	0.500	2.500	2.370
4 x 1 1/2	0.625	1.500	1.370
4 x 2	0.625	2.000	1.870
4 x 2 1/2	0.625	2.500	2.370
4 x 3	0.625	3.000	2.870
6 x 4	0.870	4.000	3.834

CLAMP FITTINGS

EG14W - TANK WELDING FERRULE

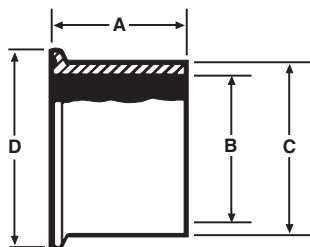

Size Tube OD	A	B	C	D
1	1.625	0.870	1.160	1.984
1 1/2	1.625	1.370	1.676	1.984
2	1.750	1.870	2.192	2.516
2 1/2	1.750	2.370	2.708	3.047
3	1.812	2.870	3.224	3.579
4	2.125	3.834	4.256	4.682
6	4.250	5.782	6.500	6.570

EG14W-C6L - ASME CODED TANK FERRULE

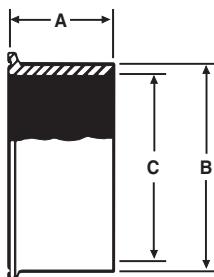

Size Tube OD	A	B	C
1	1.625	1.160	0.870
1 1/2	1.625	1.676	1.370
2	1.750	2.192	1.870
2 1/2	1.750	2.708	2.370
3	1.812	3.224	2.870
4	2.125	4.256	3.834
6	4.250	6.500	5.782

EG14WSL-C6L - ASME CODED TANK FERRULE LONG

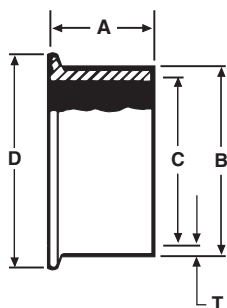

Size Tube OD	A	B	C	D	Nom. Wall (T)
1	2.500	1.160	0.870	1.984	0.145
1 1/2	2.500	1.676	1.370	1.984	0.153
2	2.500	2.192	1.870	2.516	0.161
2 1/2	3.500	2.708	2.370	3.047	0.169
3	4.500	3.224	2.870	3.579	0.177
4	4.500	4.256	3.834	4.682	0.211
6	6.250	6.500	5.782	6.570	0.359

CLAMP FITTINGS

EG14WL - TANK WELDING FERRULE

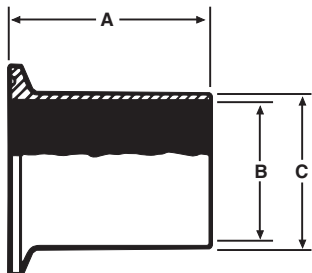

Size Tube OD	A	B	C
1	3.000	0.870	1.000
1 1/2	3.000	1.370	1.500
2	3.000	1.870	2.000
2 1/2	3.000	2.370	2.500
3	4.000	2.870	3.000
4	4.000	3.834	4.000
6	6.000	5.782	6.000
8	6.000	7.782	8.000
10	6.000	9.730	10.000
12	6.000	11.730	12.000

EG14RT - RUBBER HOSE ADAPTER

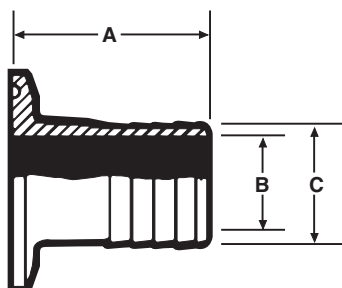

Size Tube OD	A	B	C
1/2	2.000	0.370	0.500
3/4	2.000	0.620	0.750
1	3.500	0.870	1.000
1 1/4	3.500	1.185	1.250
1 1/2	3.500	1.370	1.500
2	3.500	1.870	2.000
2 1/2	3.500	2.370	2.500
3	3.500	2.870	3.000
4	3.625	3.834	4.000
6	8.875	5.782	6.000

EG14RT - RUBBER HOSE ADAPTER REDUCER (T316L)

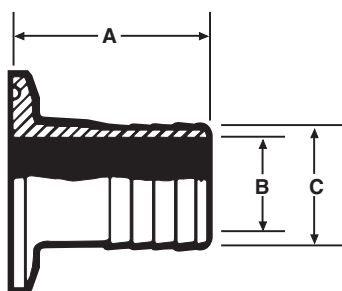

Size Tube OD	A	B	C
1 x 1/2	2.000	0.370	0.500
1 x 3/4	2.000	0.620	0.750
1 1/2 x 1 1/4	3.500	1.120	1.250
2 x 1	3.500	0.870	1.000
2 x 1 1/2	3.500	1.370	1.500
2 1/2 x 2	3.500	1.870	2.000
3 x 2	3.500	1.870	2.000
3 x 2 1/2	3.500	2.370	2.500
4 x 2 1/2	3.625	2.370	2.500
4 x 3	3.625	3.870	3.000

CLAMP FITTINGS

EG14HT - TYGON HOSE ADAPTER

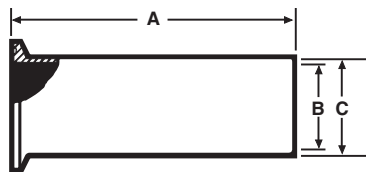

Size Tube OD	A	B	C
1	4.500	0.870	1.000
1 1/2	4.500	1.370	1.500
2	4.500	1.870	2.000
2 1/2	4.500	2.370	2.500
3	4.500	2.870	3.000
4	4.625	3.834	4.000

EG17PR - ADAPTER

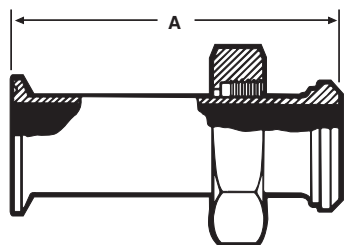

Size Tube OD	A
1	2.500
1 1/2	2.625
2	2.625
2 1/2	2.875
3	2.875
4	2.875

EG17TR - ADAPTER



Size Tube OD	A
1	1.187
1 1/2	1.187
2	1.218
2 1/2	1.343
3	1.437
4	2.125

EG21 - MALE ADAPTER (N.P.T. Pipe Threads)

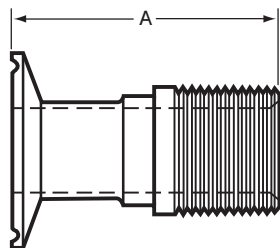

Size Tube OD	A
1	2.875
1 1/4	2.875
1 1/2	2.875
2	2.937
2 1/2	3.437
3	3.625
4	3.812
6	4.875

1 inch through 4 inch are supplied with wrench flats

EG21-6L - MALE ADAPTER REDUCING (T316L)

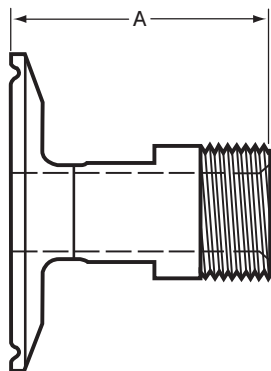

Size Tube OD	A
3/4 x 1/2	See MaxPure Catalog - TEG21
1 x 1/2	2.125
1 x 3/4	2.125
1 1/2 x 1/2	2.125
1 1/2 x 3/4	2.125
1 1/2 x 1 1/4	2.250
2 x 1	2.250
2 x 1 1/4	2.250
2 x 1 1/2	2.250
2 1/2 x 1 1/2	2.250
2 1/2 x 2	2.312
3 x 1 1/2	2.250
3 x 2	2.312
3 x 2 1/2	2.812
4 x 2	2.312
4 x 2 1/2	2.812
4 x 3	3.000
6 x 4	3.062

Sanitary Clamp end dimension listed first.

EG22 - FEMALE ADAPTER (N.P.T. Pipe Threads)

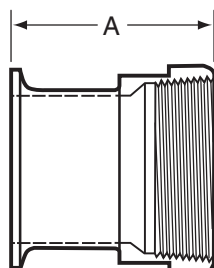

Size Tube OD	A
1	2.250
1 1/4	2.562
1 1/2	2.562
2	2.562
2 1/2	2.750
3	2.937
4	3.125

1 inch through 4 inch are supplied with wrench flats

CLAMP FITTINGS

EG22 - FEMALE ADAPTER REDUCING (T316L)

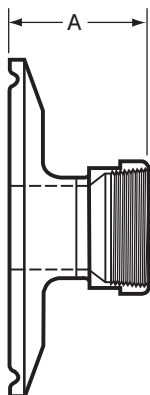

Size Tube OD	A
3/4 x 1/2	See MaxPure Catalog - TEG22
1 x 1/2	1.625
1 x 3/4	1.625
1 1/2 x 1/2	1.625
1 1/2 x 3/4	1.625
1 1/2 x 1 1/4	2.560
2 x 1	1.625
2 x 1 1/4	1.927
2 x 1 1/2	1.937
2 1/2 x 1 1/2	1.937
2 1/2 x 2	1.937
3 x 1 1/2	1.937
3 x 2	1.937
3 x 2 1/2	2.125
4 x 2	2.062
4 x 2 1/2	2.250
4 x 3	2.437

Sanitary Clamp end dimension listed first.

EG16A - SOLID END CAP



Size Tube OD	A	B
1/2 & 3/4	0.992	0.200
1 & 1 1/2	1.984	0.250
2	2.516	0.250
2 1/2	3.047	0.250
3	3.579	0.250
4	4.682	0.312
5	5.692	0.385
6	6.570	0.437
8	8.570	0.437
10	10.570	0.500
12	12.570	0.500

1 1/2" caps are used on both 1" and 1 1/2" lines.

3/4" caps are used on both 1/2" & 3/4" lines.

CLAMP FITTINGS

EG23B-6L - CLAMP THERMOMETER CAPS (T316L)

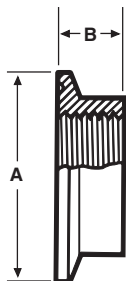

Size Tube OD	A	B
*1	1.984	0.625
1 1/2	1.984	0.625
2	2.516	0.625
2 1/2	3.047	0.625
3	3.579	0.625
4	4.682	0.625

*STD - 1/2 FNPT. All others 3/4" FNPT

Note: Other tap sizes are available.

GASKETS



Gasket Materials	Part Number	Flange Type
Buna N	EG40	EG40F
EPDM	EG40E	EG40FE
Teflon	EG40T	
Viton®	EG40V	EG40FV
Silicone	EG40S	EG40FS
TEF-Steel	EG40TS	
Envelope Type		
Teflon with EPDM Filler	EG40GR	
Teflon with Viton Filler	EG40GRV	

Available in 1/2" to 12" sizes.

13MHM - HEAVY DUTY CLAMP

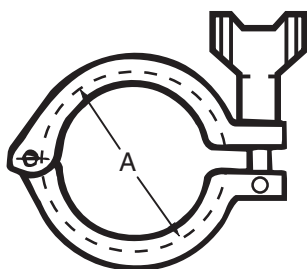

Size Tube OD	A
3/4	1.125
1 1/2	2.122
2	2.654
2 1/2	3.185
3	3.717
4	4.820
5	5.817
6	6.695
8	8.695
10	10.695
12*	12.695

Wing Nuts tightened to 25 in-lbs of torque

*12" Clamp is a two piece design using two wingnuts and no hinge.

CLAMP FITTINGS

13MHHM-H - HEAVY DUTY CLAMP (Wing Nut With Hole)

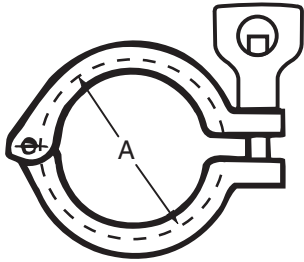

Size Tube OD	A
3/4	1.125
1 & 1/2	2.122
2	2.654
2 1/2	3.185
3	3.717
4	4.820
5	5.817
6	6.695
8	8.695
10	10.695
12	12.695

Wing Nuts tightened to 25 in-lbs of torque

13MHHMD - DOUBLE HINGED HEAVY DUTY CLAMP

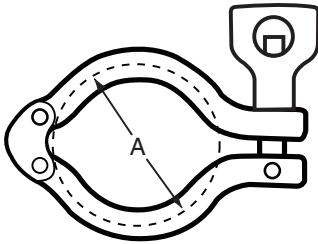

Size Tube OD	A
1 1/2	2.122
2	2.654
2 1/2	3.185
3	3.717
4	4.820

Wing Nuts tightened to 25 in-lbs of torque

13MHHMD - H - DOUBLE HINGED HEAVY DUTY CLAMP (Wing Nut With Hole)

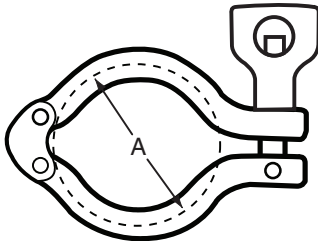

Size Tube OD	A
1 1/2	2.122
2	2.654
2 1/2	3.185
3	3.717
4	4.820

Wing Nuts tightened to 25 in-lbs of torque

13MHHS - THREE PIECE HEAVY DUTY CLAMP

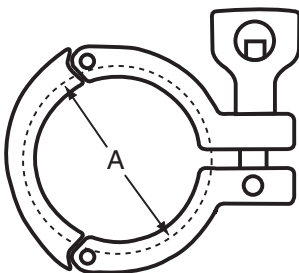

Size Tube OD	A
1 1/2	2.122
2	2.654
2 1/2	3.185
3	3.717
4	4.820

Wing Nuts tightened to 25 in-lbs of torque

CLAMP FITTINGS

13MHP - HIGH PRESSURE CLAMP

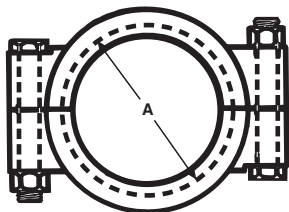

Size Tube OD	A
3/4	1.125
1 1/2	2.046
2	2.578
2 1/2	3.110
3	3.640
4	4.744
6	6.632

13MHP Style nuts tightened to 20 ft-lbs of torque

EG13 - HINGED CLAMP - (Light Duty)

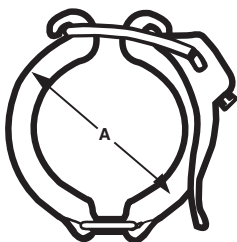

Size Tube OD	A
1 1/2	2.142
2	2.653
2 1/2	3.205
3	3.740
4	4.803

*PSI SERVICE RATINGS FOR SANITARY STAINLESS STEEL CLAMPS

Size Tube OD	13MHHM / 13MHHM - H		13MHHMD / 13MHHMD - H	
	@70°F	@250°F	@70°F	@250°F
3/4"	1500	1200		
1 1/2"	500	250	500	250
2"	450	250	450	250
2 1/2"	400	200	400	200
3"	350	150	350	150
4"	200	125	200	125
5"	175	100		
6"	150	75		
8"	100	50		
10"	40	30		
12"	30	25		

CLAMP FITTINGS

*PSI SERVICE RATINGS FOR SANITARY STAINLESS STEEL CLAMPS

Size Tube OD	13MHHS		13MHP		EG13	
	@70°F	@250°F	@70°F	@250°F	@70°F	@250°F
3/4"			1500	1200		
1 1/2"	600	300	1500	1200	150	125
2"	550	275	1000	800	150	125
2 1/2"	450	225	1000	800	150	125
3"	350	160	1000	800	150	125
4"	250	150	1000	800	150	125
5"						
6"			300	200		
8"						
10"						
12"						

*Service ratings are based upon hydrostatic tests using Standard Molded Buna-N gasket material with proper expansion of ferules, joint assembly, and the absence of shock pressure. All ratings systems are dependent upon related components in the system and proper installation. **13MHHS Style nuts tightened to 25 in-lbs of torque / 13MHP Style nuts tightened to 20 ft-lbs of torque.**

EG28A - 45° CLAMP LATERAL

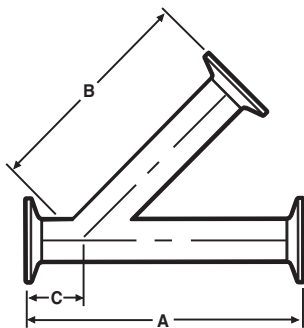

Size Tube OD	A	B	C
1	7.000	5.500	1.500
1 1/2	8.375	6.687	1.687
2	9.625	7.625	2.125
2 1/2	11.125	9.000	2.000
3	11.750	9.375	2.375
4	14.062	11.375	2.687
6	18.875	15.375	4.375

EG28B - CLAMP TRUE Y

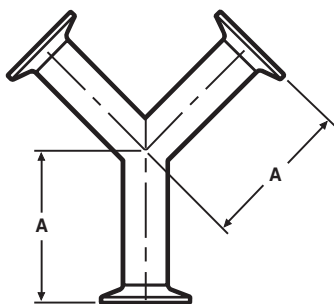

Size Tube OD	A
1	3.500
1 1/2	3.500
2	4.500
2 1/2	5.500
3	6.500
4	8.625
6	8.875

CLAMP FITTINGS

EG28RA - 45° CLAMP REDUCING LATERAL

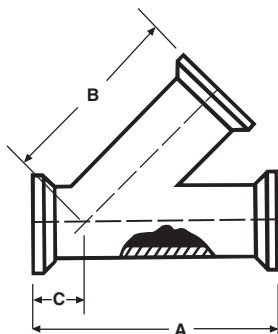

Size Tube OD	A	B	C
1 1/2 x 1	8.375	5.062	1.375
2 x 1	9.625	5.500	1.625
2 x 1 1/2	9.625	5.500	1.625
2 1/2 x 1	11.125	6.875	2.125
2 1/2 x 1 1/2	11.125	6.875	2.125
2 1/2 x 2	11.125	6.875	2.125
3 x 1	11.750	8.250	2.500
3 x 1 1/2	11.750	8.250	2.500
3 x 2	11.750	8.250	2.500
3 x 2 1/2	11.750	8.250	2.500
4 x 1	14.062	10.000	3.000
4 x 1 1/2	14.062	10.000	3.000
4 x 2	14.062	10.000	3.000
4 x 2 1/2	14.062	10.000	3.000
4 x 3	14.062	10.000	3.00

EG31CC - CONCENTRIC REDUCER

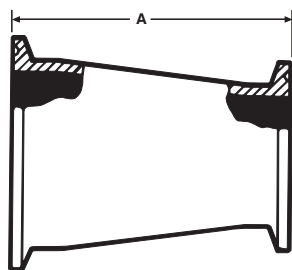

Size Tube OD	A
3/4 x 1/2	2.000
1 x 1/2	2.000
1 x 3/4	2.000
1 1/2 x 1/2	3.000
1 1/2 x 3/4	3.000
1 1/2 x 1	3.000
1 1/2 x 1 1/4	2.000
2 x 1	5.000
2 x 1 1/4	2.000
2 x 1 1/2	3.000
2 1/2 x 1	7.000
2 1/2 x 1 1/2	5.000
2 1/2 x 2	3.000
3 x 1 1/2	7.000
3 x 2	5.000
3 x 2 1/2	3.000
4 x 2	9.125
4 x 2 1/2	7.125
4 x 3	5.125
6 x 3	6.875
6 x 4	7.000

EG32CC - ECCENTRIC REDUCER

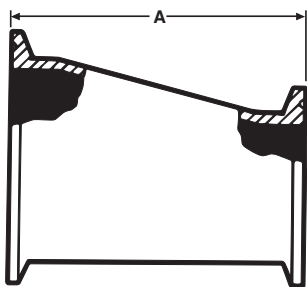

Size Tube OD	A
3/4 x 1/2	2.000
1 x 1/2	3.000
1 x 3/4	2.000
1 1/2 x 1/2	5.000
1 1/2 x 3/4	4.000
1 1/2 x 1	3.000
1 1/2 x 1 1/4	2.000
2 x 1	5.000
2 x 1 1/4	2.000
2 x 1 1/2	3.000
2 1/2 x 1	7.000
2 1/2 x 1 1/2	5.000
2 1/2 x 2	3.000
3 x 1 1/2	7.000
3 x 2	5.000
3 x 2 1/2	3.000
4 x 2	9.125
4 x 2 1/2	7.125
4 x 3	5.125
6 x 3	6.875
6 x 4	7.000

EG31PC - ADAPTER REDUCER (Concentric)

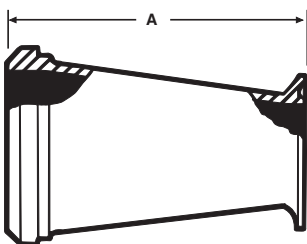

Size Tube OD	A
*1 1/2 x 1	3.187
2 x 1	5.218
2 x 1 1/2	3.218
2 1/2 x 1 1/2	5.343
2 1/2 x 2	3.343
3 x 2	5.437
3 x 2 1/2	3.437
4 x 2 1/2	7.500
4 x 3	5.500

*Hex nut furnished

CLAMP FITTINGS

EG32PC - ADAPTER REDUCER (Eccentric)

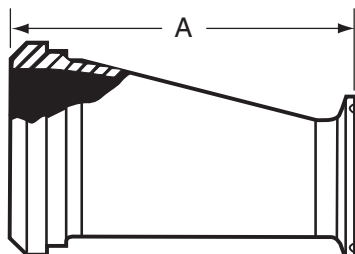

Size Tube OD	A
*1 1/2 x 1	3.187
2 x 1	5.218
2 x 1 1/2	3.218
2 1/2 x 1 1/2	5.343
2 1/2 x 2	3.343
3 x 2	5.437
3 x 2 1/2	3.437
4 x 2 1/2	7.500
4 x 3	5.500

*Hex nut furnished

EG31CP - ADAPTER REDUCER (Concentric)

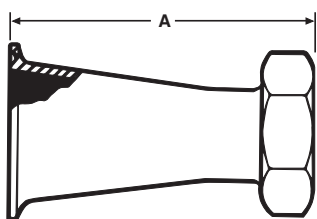

Size Tube OD	A
1 1/2 x 1	3.875
2 x 1	5.875
2 x 1 1/2	4.000
2 1/2 x 1 1/2	6.000
2 1/2 x 2	4.000
3 x 2	6.000
3 x 2 1/2	4.250
4 x 2 1/2	8.378
4 x 3	6.378

EG32CP - ADAPTER REDUCER (Eccentric)

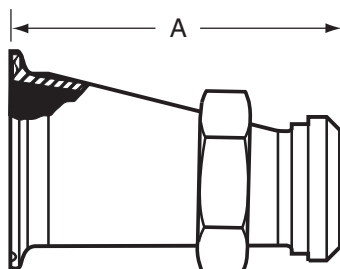

Size Tube OD	A
1 1/2 x 1	3.875
2 x 1	5.875
2 x 1 1/2	4.000
2 1/2 x 1 1/2	6.000
2 1/2 x 2	4.000
3 x 2	6.000
3 x 2 1/2	4.250
4 x 2 1/2	8.378
4 x 3	6.378

CLAMP FITTINGS

EG31TC - ADAPTER REDUCER (Concentric)

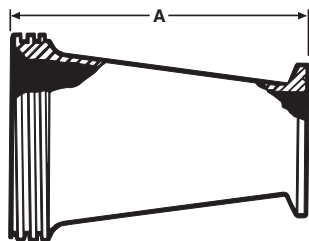

Size Tube OD	A
1 1/2 x 1	3.187
2 x 1	5.218
2 x 1 1/2	3.218
2 1/2 x 1 1/2	5.343
2 1/2 x 2	3.343
3 x 2	5.437
3 x 2 1/2	3.437
4 x 2 1/2	7.500
4 x 3	5.500

EG32TC - ADAPTER REDUCER (Eccentric)

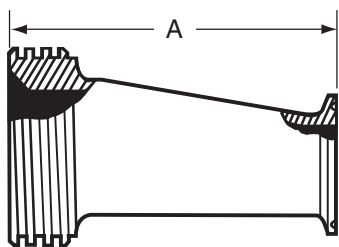

Size Tube OD	A
1 1/2 x 1	3.187
2 x 1	5.218
2 x 1 1/2	3.218
2 1/2 x 1 1/2	5.343
2 1/2 x 2	3.343
3 x 2	5.437
3 x 2 1/2	3.437
4 x 2 1/2	7.500
4 x 3	5.500

EG31CT - ADAPTER REDUCER (Concentric)

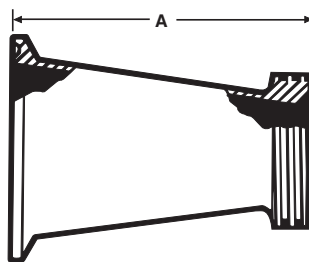

Size Tube OD	A
1 1/2 x 1	3.187
2 x 1	5.187
2 x 1 1/2	3.187
2 1/2 x 1 1/2	5.187
2 1/2 x 2	3.218
3 x 1 1/2	7.187
3 x 2	5.218
3 x 2 1/2	3.343
4 x 2	9.343
4 x 2 1/2	7.468
4 x 3	5.562

CLAMP FITTINGS

EG32CT - ADAPTER REDUCER (Eccentric)

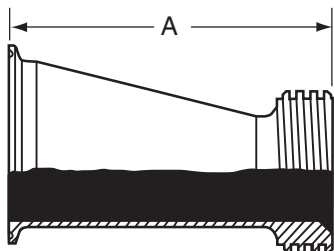

Size Tube OD	A
1 1/2 x 1	3.187
2 x 1	5.187
2 x 1 1/2	3.187
2 1/2 x 1 1/2	5.187
2 1/2 x 2	3.218
3 x 1 1/2	7.187
3 x 2	5.218
3 x 2 1/2	3.343
4 x 2	9.343
4 x 2 1/2	7.468
4 x 3	5.562

CLAMP FITTINGS SCHEDULE 5 & 10

EG2CS-5-6L - FERRULE

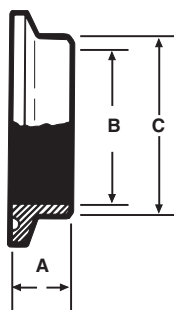

Size Pipe	A	B	C	Nom. Wall
1	0.500	1.185	1.315	0.065
1 1/2	0.500	1.770	1.900	0.065
2	0.500	2.245	2.375	0.065
2 1/2	0.500	2.709	2.875	0.083
3	0.500	3.334	3.500	0.083
4	0.625	4.334	4.500	0.083

EG2CS-10-6L - FERRULE

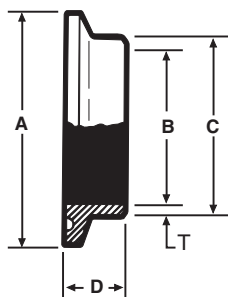

Size Pipe	A	B	C	D	Nom. Wall
1/2	1.984	0.674	0.840	0.500	0.083
3/4	1.984	0.884	1.050	0.500	0.083
1	1.984	1.097	1.315	0.500	0.109
1 1/2	2.516	1.682	1.900	0.500	0.109
2	3.047	2.157	2.375	0.500	0.109
2 1/2	3.579	2.635	2.875	0.500	0.120
3	4.125	3.260	3.500	0.500	0.120
4	5.125	4.260	4.500	0.625	0.120

CLAMP FITTINGS SCHEDULE 5 & 10

EG14AM7-5-6L - FERRULE

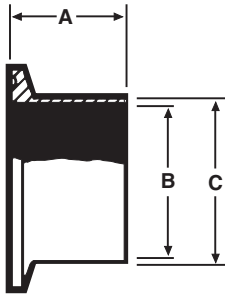

Size Pipe	A	B	C	Nom. Wall
1	1.125	1.185	1.315	0.065
1 1/2	1.125	1.770	1.900	0.065
2	1.125	2.245	2.375	0.065
2 1/2	1.125	2.709	2.875	0.083
3	1.125	3.334	3.500	0.083
4	1.125	4.334	4.500	0.083

EG14AM7-10-6L - FERRULE

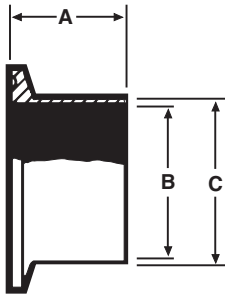

Size Pipe	A	B	C	Nom. Wall
1	1.125	1.097	1.315	0.109
1 1/2	1.125	1.682	1.900	0.109
2	1.125	2.157	2.375	0.109
2 1/2	1.125	2.635	2.875	0.120
3	1.125	3.260	3.500	0.120
4	1.125	4.260	4.500	0.120

EG16A-5-6L - CAP



Size Pipe	A	B
1	1.984	0.250
1 1/2	2.516	0.250
2	3.047	0.250
2 1/2	3.579	0.250
3	4.125	0.250
4	5.125	0.250

13MHHM-5 - CLAMP

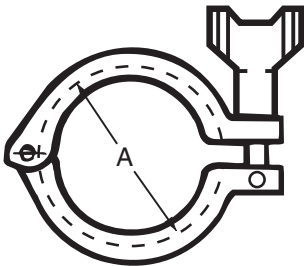

Size Pipe	A
1	2.122
1 1/2	2.654
2	3.185
2 1/2	3.717
3	4.250
4	5.250

CLAMP FITTINGS SCHEDULE 5 & 10

*PSI SERVICE RATINGS FOR SANITARY STAINLESS STEEL CLAMPS

Pipe Size	13MHHM	
	@70°F	@250°F
1"	500	250
1 1/2"	450	250
2"	400	200
2 1/2"	350	150
3"	250	135
4"	175	100

GASKETS



Gasket Materials	Part Number
Buna N	EG40-5-SIZE
Teflon	EG40T-5-SIZE
Viton	EG40V-5-SIZE
Silicone	EG40S-5-SIZE
EPDM	EG40E-5-SIZE

Available in 1" to 4" sizes.